

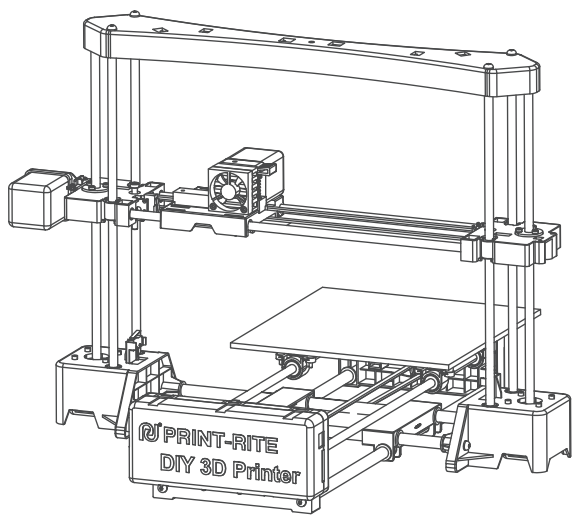

DIY 3D Printer

USER MANUAL



* Carefully and thoroughly read this manual before using



All rights reserved © Print-rite

Chapter 1 Safety and Compliance.....	03
Chapter 2 Specification	04
Chapter 3 Print Principle	05
Chapter 4 Accessory Checklist	06
Chapter 5 Electrical Connection.....	07
Chapter 6 Install and Setup Repetier-Host	
6.1 Install Repetier-Host	08
6.2 Setup Repetier-Host	09
Chapter 7 DIY 3D Printer Calibration and Print	
7.1 Calibration	10~13
7.2 Filament Test	14~15
7.3 Print with Repetier-Host	16~18
Chapter 8 FAQ	19

This User Manual is designed to start your journey with DIY 3D Printer in the right direction.

Welcome you to the world of DIY 3D Printer.

Following this manual will help you make amazing products.

In this manual, Safety Alert Symbol will be marked in the start of safety message. The Safety Alert Symbol means potential safety hazards which will possibly harm you or others and cause product or property loss.

Safety Alert Symbol



WARNING: HOT SURFACE, DO NOT TOUCH

Desktop 3D Printer has high temperature when working.
Make sure the Desktop 3D Printer cool down before touching inside.



WARNING: HAZARDOUS MOVING PARTS, KEEP FINGERS AND OTHER BODY PARTS AWAY

The moving parts of Desktop 3D Printer will possibly cause harm. Do not touch the Desktop 3D Printer inside when the printer is working.



WARNING: Make sure stand by Desktop 3D Printer when it working.



CAUTION: Be careful when using Print-Rite unapproved material, which may damage Printer and impact print quality.



CAUTION: Disconnect power plug from power socket during emergency.



CAUTION: Power socket must be located near the Printer and within reach.



CAUTION: Place Desktop 3D Printer in well-ventilated area as it will melt plastic and emit plastic odor when printing.



Printing

Print Technology: Fused Deposition
Modeling
Construction Dimension: 200*200*170mm
Layer Resolution Setting: 0.1~0.4mm
Positional Accuracy: XY: 0.011mm
Z: 0.00 25mm
Filament: PLA
Filament Diameter: 1.75mm
Nozzle Diameter: 0.4mm

Mechanical

Frame: Steel + Engineering Plastic
Platform: Engineering Plastic
XYZ Bearing: Steel
Stepper Motors:
1.8° step angle,
1/16 micro-stepping

Electrical

Storage Temperature: 0 °C ~ 32 °C [32 °F~ 90 °F]
Operating Temperature: 15 °C ~ 32 °C [60 °F~ 90 °F]
Power: 60W
Input Voltage: 110V~240V 50/60HZ

Dimension

Printer Size: 502*536*382MM
Package Size: 565*290*285MM

Software

Software package: REPETIER-HOST 0.95F
File Type: .STL, .GCO
Operating System: WINDOWS 7, MAC OS, LINUX
Connection: USB

Chapter 3 Print Principle

DIY 3D Printer makes solid, three-dimensional objects by melting PRINT-RITE PLA filament.

The designed 3D files are converted into DIY 3D Printer command through computer software “Repetier-Host” and sent to the printer via USB Cable. Then, the printer will heat up and melt PRINT-RITE PLA filament and push it out from the nozzle to make a solid object layer by layer. This method is called Fused Deposition Modeling or FDM.

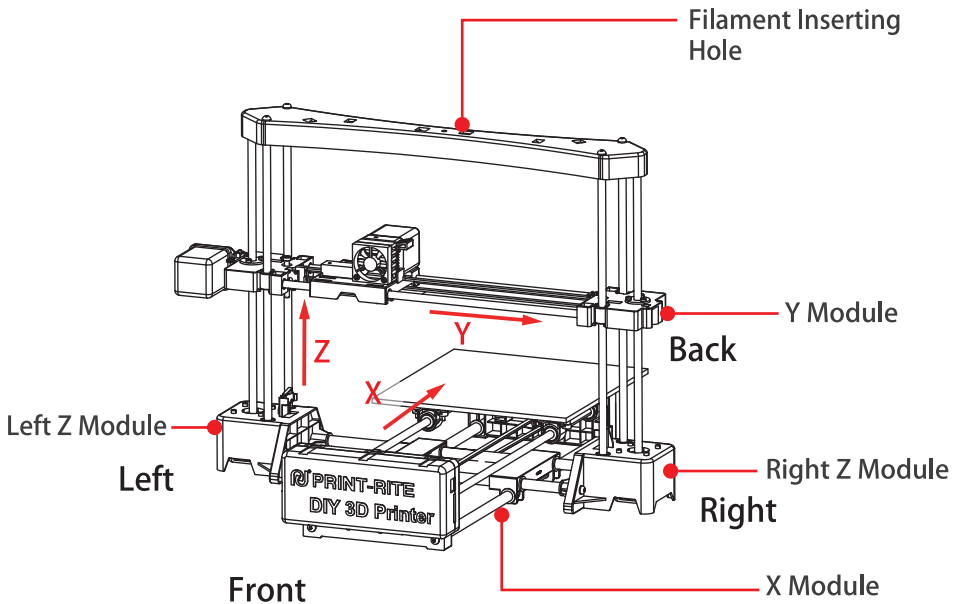

Chapter 4 Accessory Checklist



PLA Filament -----



Spool Holder -----



Flash Drive 1pc -----

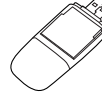

Power Cable 1pc -----

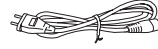

USB Cable 1pc -----



Screw Drivers -----



Test Sheet 1pc -----

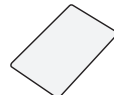

Chapter 5 Electrical Connection

5.1 Properly connect wires to the Mainboard as below picture.

(Each wires are properly labelled)

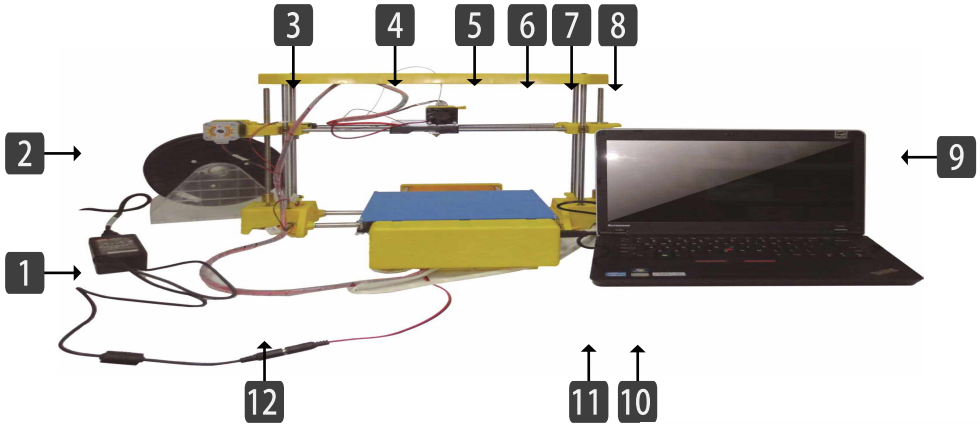

- | | | |
|------------|----------|-------------------|
| 1. X-MOTOR | 5. FAN | 9. USB Cable Port |
| 2. Y-MOTOR | 6. XSTOP | 10. ETEMP |
| 3. Z-MOTOR | 7. YSTOP | 11. HOTEND |
| 4. E-MOTOR | 8. ZSTOP | 12. POWER INPUT |

- 3R. connect to Z-Motor
- 3L. connect to Z-Motor
- 2A connect to Y-Motor

NOTE: Make sure assemble Z Limit Switch on the Left Z Module.

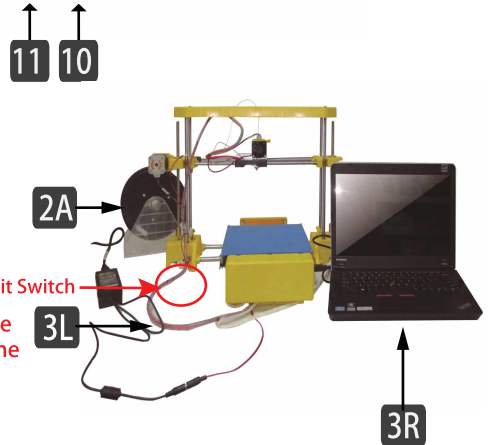

5.2 DIY Printer set up ready.

Connect to the power using power cable, connect to the computer using USB cable to print.

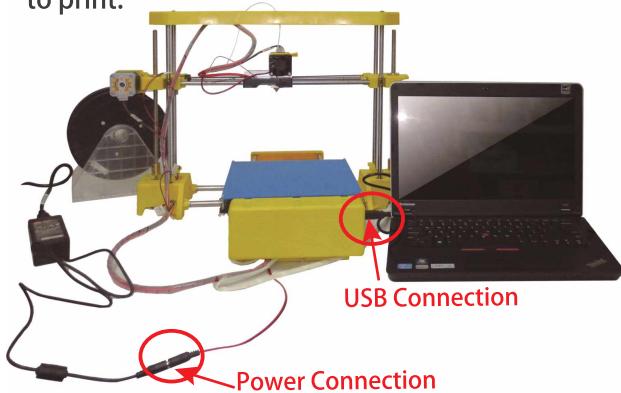

Reminder during Electrical Connection

1. User can connect the wire to the mainboard base on the label on each wire.
2. Do not connect power supply during electrical set up.
3. Harness the wire cable after connection. Avoid wire entanglement such no connection problem.

6.1 Install REPETIER-HOST

REPETIER-HOST is a software which is used to slice the 3D models (.GCO .STL) and command DIY Printer to print.

Computer Operation System: WINDOWS 7, MAC OS, LINUX

- 1 Find "setupColido-RepetierHost_1_5_5.exe" in SD Card, double click to start. You can select the setup language during the installation.
- 2 Start to install. (The computer will ask "Do you want to allow the following program to make changes to this computer?" ,please click "Yes" to go proceed software installation.



- 3 Repetier-Host is installed in the computer and show as below picture, Click "Install Arduino driver" , "Install FTDI serial driver" and "Launch Print-Rite CoLiDo Repetier-Host" and then click "Finish" to go ahead.

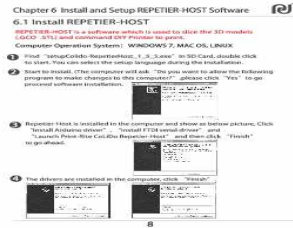

- 4 The drivers are installed in the computer, click "Finish" .

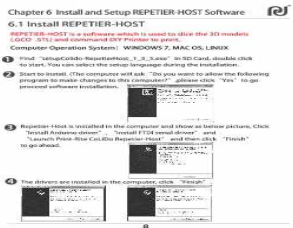
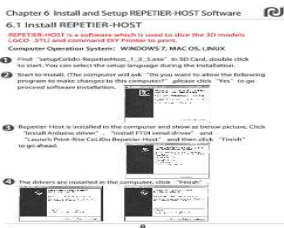

6.2 Setup REPETIER-HOST

- 1 Double click to go into "Repetier - Host" software.
- 2 Select language, click "Printer Settings" .

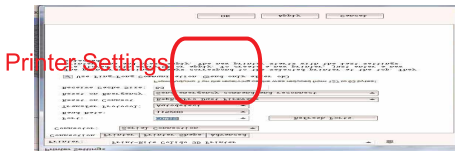
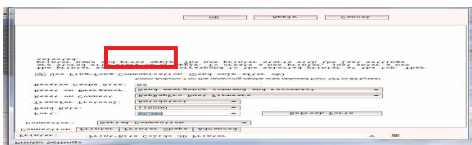

- 3 Connection: Select Printer: CoLiDo DIY 3D Printer; Baud rate: 115200.
Select the correct Port COMx such the printer can connect with the Repetier.

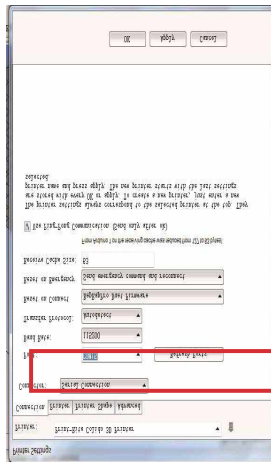
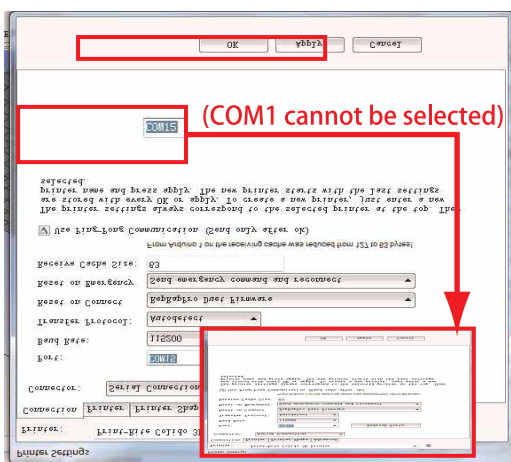

NOTE: COMx dependant on different computer or 3D printer you are using. Different 3D printer has different COMx, which can be located and matched with COMx in Device Manager.

- 4 Click "Printer Shape" and set parameter as below picture.
After filled, click "Apply" and "OK" . Finish Repetier-Host Setup.

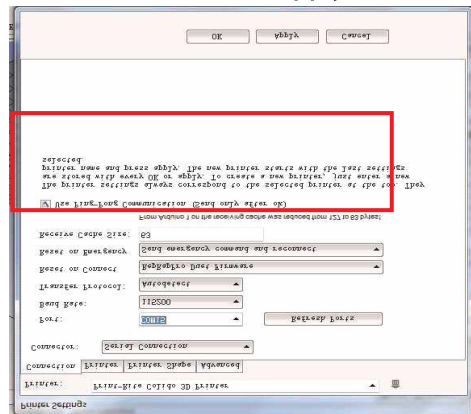

7.1 Calibration

The Printer Head and the platform calibration is very important. Incorrect calibration will impact printing quality.

7.1.1 “Manual Control” introduction (It will show the meaning when point the button)

DIY Printer calibration and printing are need to be controlled by “Manual Control” menu.

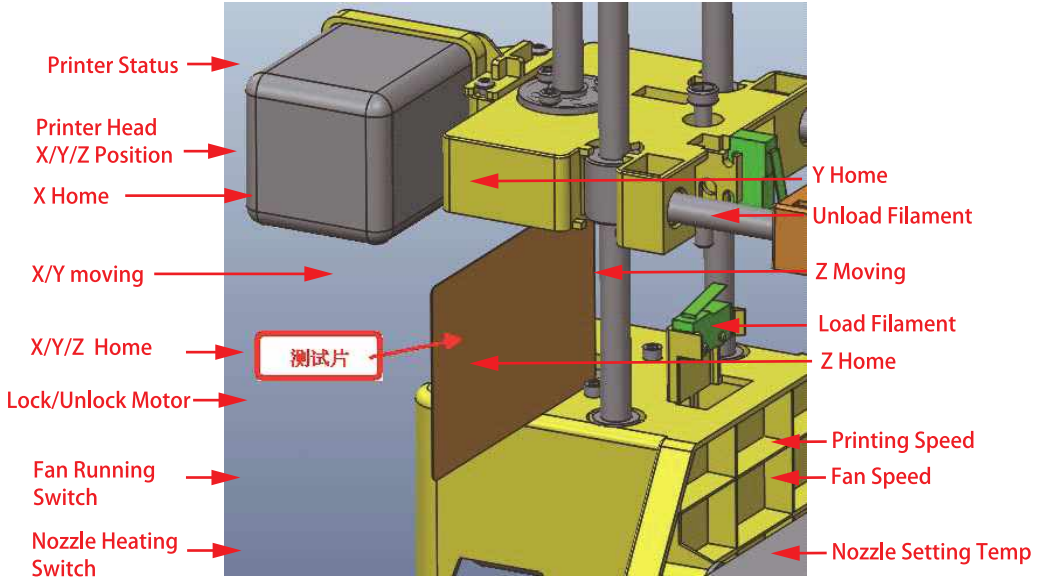

7.1.2 Turn off the printer. Rotate the two Z screw rods at the same time until the two sides distance between the Y Module and Z Module is equal to the test sheet width. It is to ensure the Y module is in level.

Left Y Base

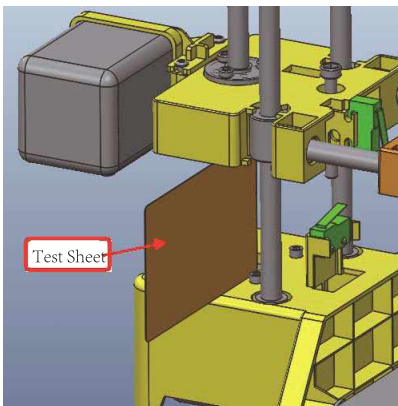

Right Y Base

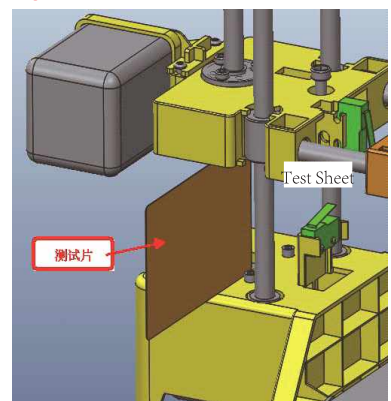

7.1 Calibration

7.1.3 Move away the platform from the nozzle tip before calibration. This is to avoid the nozzle and the platform damage.

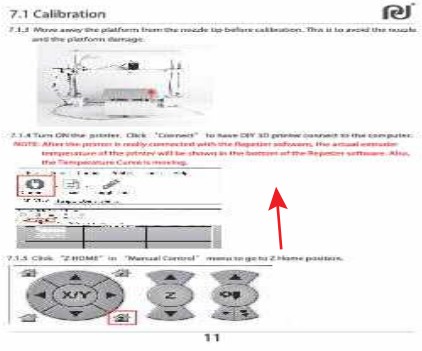

7.1.4 Turn ON the printer. Click “Connect” to have DIY 3D printer connect to the computer.
NOTE: After the printer is really connected with the Repetier software, the actual extruder temperature of the printer will be shown in the bottom of the Repetier software. Also, the Temperature Curve is moving.

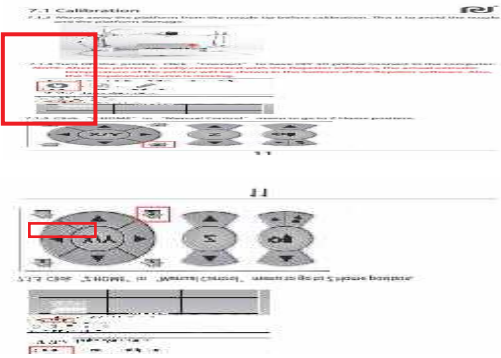

7.1.5 Click “Z HOME” in “Manual Control” menu to go to Z Home position.

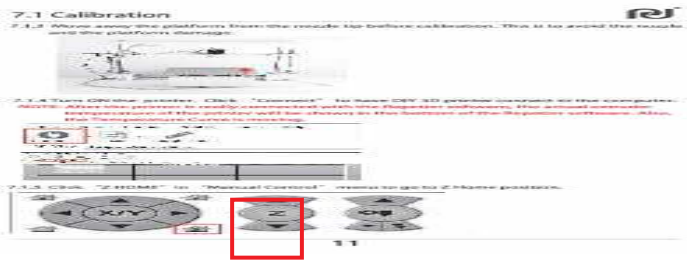

7.1 Calibration

7.1.6 Use the test sheet to check the gap between the nozzle tip and the platform if meet “Calibration Standard Condition” as below picture.

Calibration Standard Condition:

The test sheet must be lay down flat on the platform, and the test sheet must be just touching the nozzle tip.

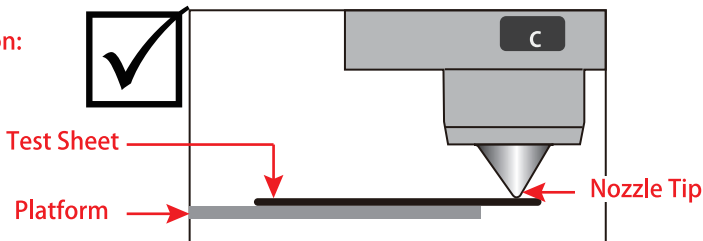

If the calibration standard condition is not met, the platform level must be adjusted by adjusting the Z Limit Screw.

Condition 1: There is a gap between the nozzle tip and the test sheet

Adjustment 1: Rotate the Z Limit Screw counterclockwise direction slightly using screw driver to have Z Limit Screw a little more far to the Z Limit Switch as below picture. Click “Z HOME” to check the calibration condition until the nozzle tip just touch the test sheet as standard condition.

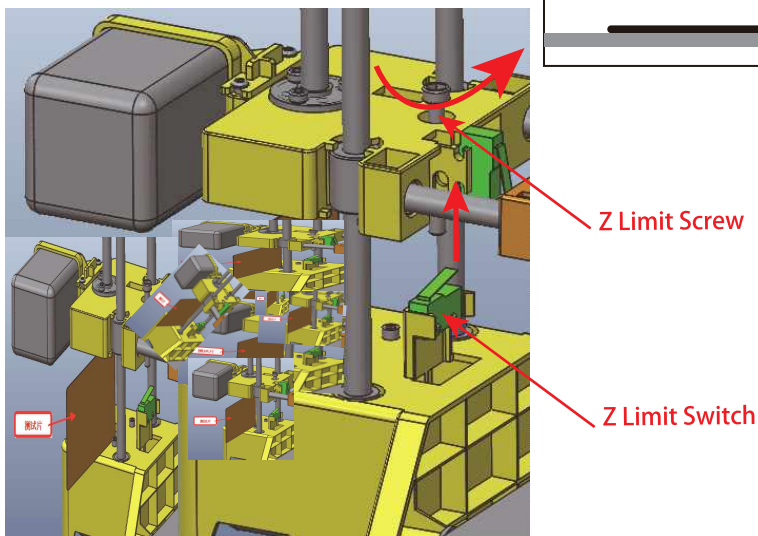
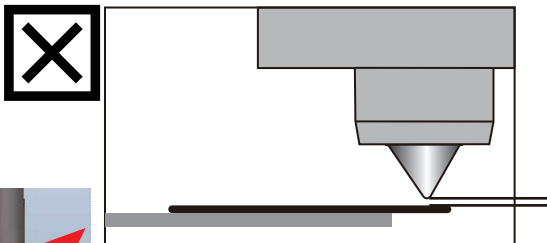

7.1 Calibration

Condition 2: The test sheet is over the nozzle tip.

Adjustment 2: Click “+Z” to move up the nozzle 5mm, rotate the Z Limit Screw clockwise direction using screw driver to have the Z Limit Screw move more close to the Z Limit Switch as below picture.

Click “Z HOME” to check the calibration condition until the nozzle tip just touch the test sheet as standard condition.

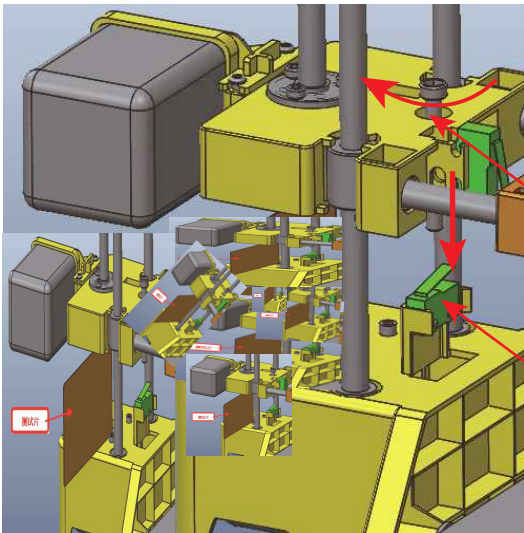
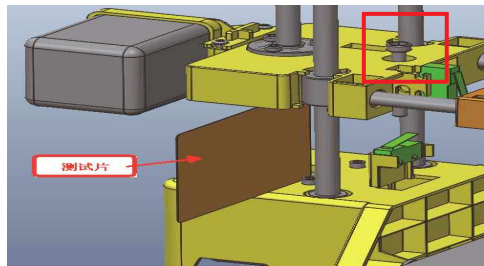
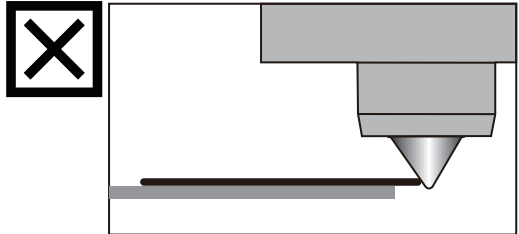

Z Limit Screw

Z Limit Switch

7.2 Filament Test

7.2.1 Load Filament

7.2.1.1 Pull PRINT-RITE PLA Filament from the filament spool. Cut the filament tip using scissor (making flat as below picture) for easy installation.

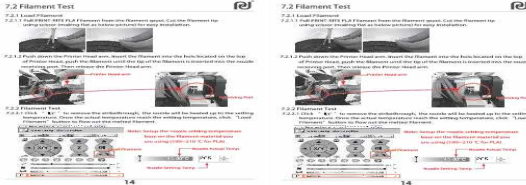

7.2.1.2 Push down the Printer Head arm. Insert the filament into the hole located on the top of Printer Head, push the filament until the tip of the filament is inserted into the nozzle receiving port. Then release the Printer Head arm.

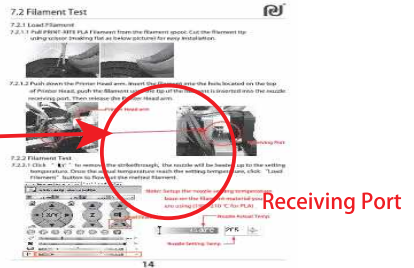
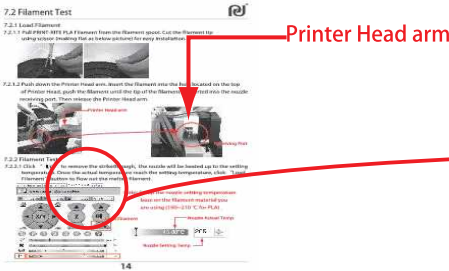

7.2.2 Filament Test

7.2.2.1 Click “~~OK~~” to remove the strikethrough, the nozzle will be heated up to the setting temperature. Once the actual temperature reach the setting temperature, click “Load Filament” button to flow out the melted filament.

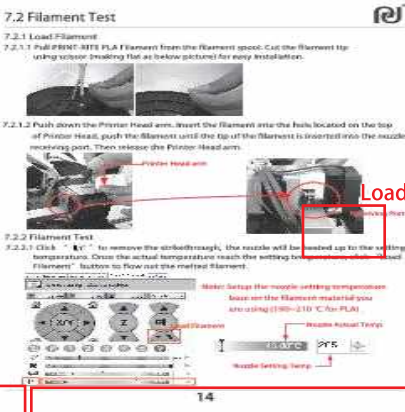

Note: Setup the nozzle setting temperature base on the filament material you are using (190~210 °C for PLA) .

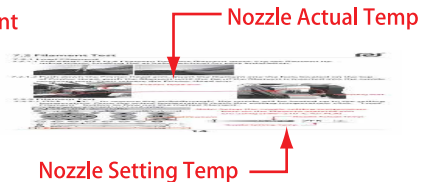

7.2 Filament Test

7.2.2.2 Check the melted filament condition flowing out from the nozzle.

Good condition:

The melted filament flow out smoothly and continuously from the nozzle.

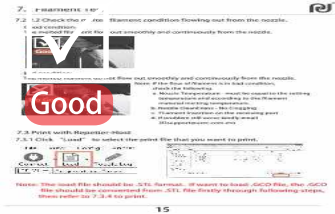

Bad condition:

The melted filament do not flow out smoothly and continuously from the nozzle.

Note: If the flow of filament is in bad condition, check the following.

- a. Nozzle Temperature - must be equal to the setting temperature and according to the filament melting temperature.
- b. Nozzle Cleanliness - No Clogging
- c. Filament Insertion on the receiving part
- d. If problem still occur kindly email 3Dsupport@utec.com.mo



7.3 Print with Repetier-Host

7.3.1 Click “Load” to select the print file that you want to print.

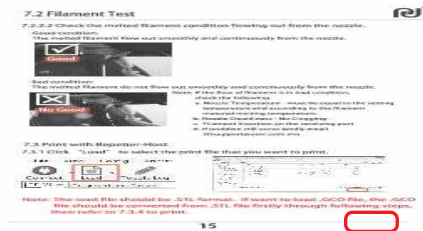
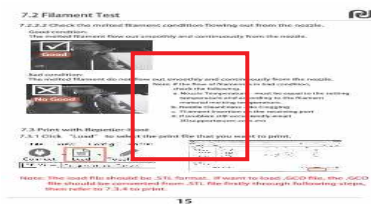

Note: The load file should be .STL format. If want to load .GCO file, the .GCO file should be converted from .STL file firstly through following steps, then refer to 7.3.4 to print.

7.3 Print with Repetier-Host

7.3.2 Select the print effect that you want to print, select PLA or ABS filament that you are using. Then click “Slice with Slic3r” to generate G-code.



Step1: Select “Slic3r”

Step 2: Select the effect that you want to print

- CoLiDo Best - For small object
- CoLiDo standard - For big object
- CoLiDo standard ABS - For ABS material object
- CoLiDo draft - For fast printing
- CoLiDo support - For the model adding support
- CoLiDo thin wall - For the thickness lower 2mm thin wall object

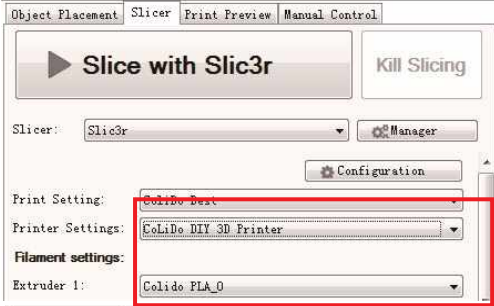

Step 3: Select printer type “CoLiDo DIY 3D Printer” you are using.



Step 4: Select filament setting “CoLiDo PLA_0” .

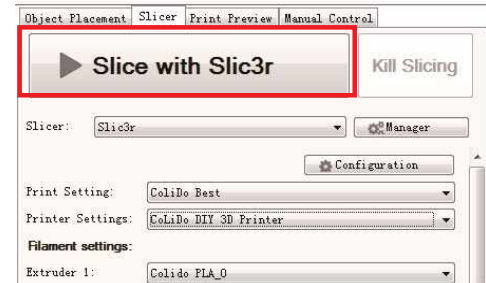

Step 5: Click “Slice with Slic3r” to slice the file to generate g-code

7.3 Print with Repetier-Host

7.3.3 After slice, you can see the estimated printing time and filament usage. Also, you can see the printed shape of the object in the “3D View” .

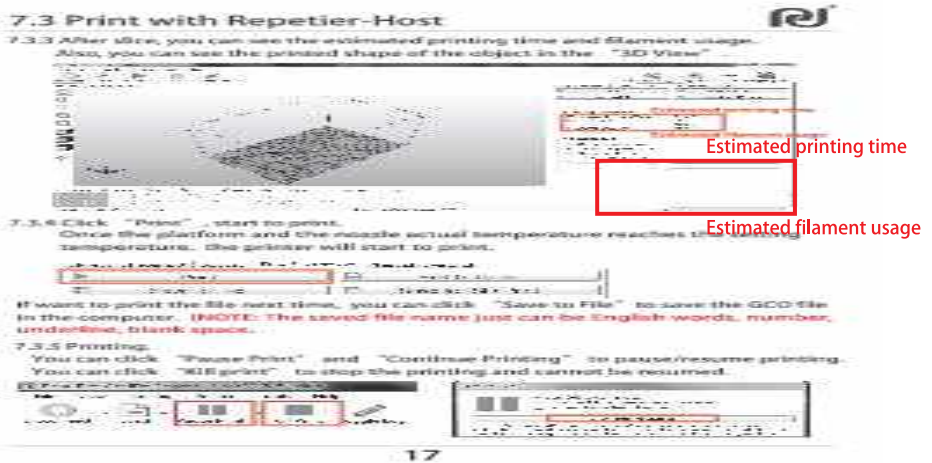

7.3.4 Click “Print” , start to print.

Once the platform and the nozzle actual temperature reaches the setting temperature, the printer will start to print.



If want to print the file next time, you can click “Save to File” to save the GCO file in the computer. (NOTE: The saved file name just can be English words, number, underline, blank space.

7.3.5 Printing.

You can click “Pause Print” and “Continue Printing” to pause/resume printing. You can click “Kill print” to stop the printing and cannot be resumed.

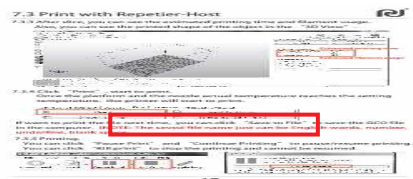
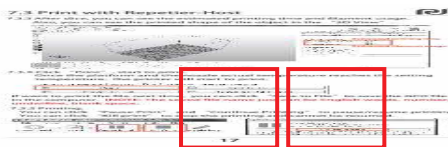

7.3 Print with Repetier-Host

7.3.6 Basic Printing Settings

1. 3D object can be adjusted such as scale down/up X/Y/Z, rotate X/Y/Z, copy, mirror, autoposition and split before slice. After adjusting the object, It is better to click "Center Object" .

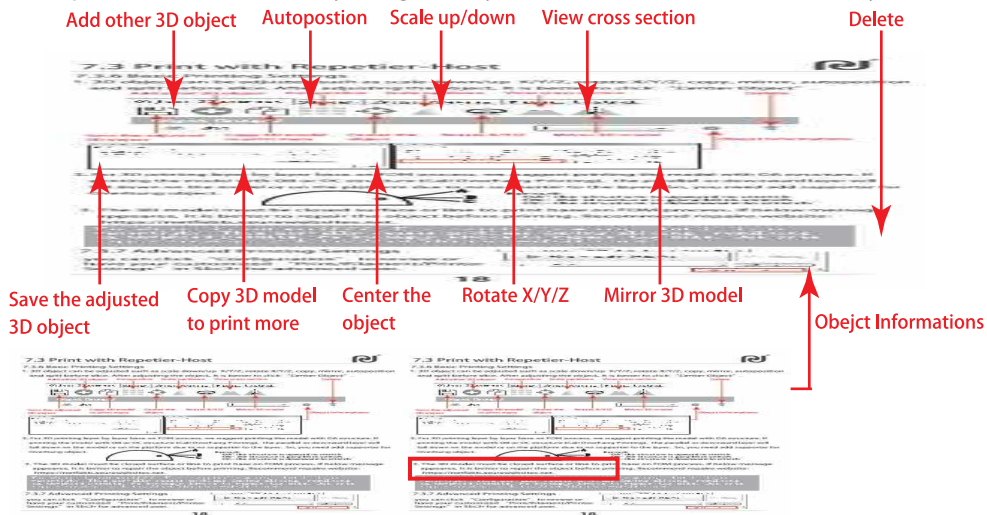

2. For 3D printing layer by layer base on FDM process, we suggest printing the model with OA structure. If printing the model with OB or OC structure (Call Overhang Printing), the parallel or downward layer will fall down on the model or on the platform due to no supporter to the layer. So, you need add supporter for Overhang object.



Remark:
 OA- the structure is upward to stretch
 OB- the structure is parallel to stretch
 OC- the structure is downward to stretch

3. The 3D model must be closed surface or line to print base on FDM process. If below message appears, it is better to repair the object before printing. Recommend reparaie website: <https://netfabb.azurewebsites.net>.

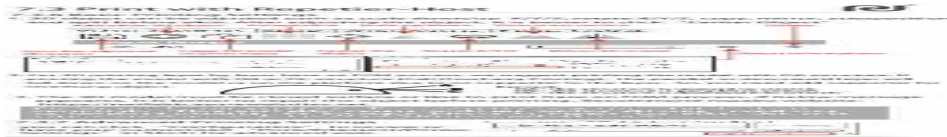

7.3.7 Advanced Printing Settings

you can click "Configuration" to review or have your customized "Print/Filament/Printer Settings" in Slic3r for advanced user.



DIY Printer	
? Question	Solution
The filament cannot come out from the nozzle during printing?	<ol style="list-style-type: none"> 1. The platform maybe too close to the nozzle tip, which will prevent the filament extruding from the nozzle. Please refer to Chapter 7.1 to re-calibrate the platform. 2. Remove the filament from the printer head , cut the filament tip flat, make a length of filament straight and re-load it into the printer head. Make sure that the filament is properly inserted into the nozzle receiving port. 3. Disassemble the printer head, check the gear which is pulling the filament into the nozzle. If there are presence of filament powder residue is filled in, clean the gear using the brush. Check also if the gear tooth is damaged. If yes, replace the gear with a new one.
The filament cannot be removed from the printer head?	<ol style="list-style-type: none"> 1. Check if the nozzle actual temperature reaches the setting temperature; 2. Heat up the nozzle to reach the setting temperature, press the printer head arm and push a bit filament into the nozzle until the filament come out from the nozzle, then pull the filament out quickly.
How to fix the clogged nozzle?	<ol style="list-style-type: none"> 1. Heat up the nozzle to reach the setting temperature, please press the printer head arm and at the same time forcedly push the filament to come out from the nozzle. 2. If still not ok, remove the filament and clean the nozzle using Allen Key in the accessory. 3. Disassemble the printer head by unlocking the screws on the Fan, clean the blocked filament inside the nozzle.
The printed object cannot stick to the platform?	<ol style="list-style-type: none"> 1. Make the temperature setting correct. For PLA, nozzle temperature is 205°C. Make sure the selected setting is matched with the material you are using. 2. Re-calibrate the platform to meet "calibration standard condition" (The test sheet must be lay down flat in the platform and the test sheet must be touching the nozzle tip).
Repetier-Host software cannot connect to 3D printer though the software installed correctly?	<ol style="list-style-type: none"> 1. Ensure the printer connect to computer with USB cable and turn on; 2. Refer to chapter 6.2 , make sure that the selection of COM port in printer setting is right. The port should be the last one when turn on the printer and matched with COM port in Device Manager. Once connected, the Temperature Curve will be moving. NOTE: "COM1" cannot be used.
How to download Repetier for Mac OS or Linux?	Go to website Repetier.com to free download the Repetier software for operation system Mac OS or Linux.
How much the printing speed?	The printer printing speed is 20~120mm/s.
The STL file cannot be sliced to gco file in Repeater software?	<p>When load STL file to Repetier software, the object will show all dark blue color in the 3D view window, it means that the file can be sliced.</p> <ol style="list-style-type: none"> 1. If the object show some red and some green, it mean the object has unclosed line or surface and cannot be sliced. Also, Repetier-Host will show warning message to suggest repairing the object. 2. If the object is not touch with he printing area or exceed the printing area, please click " " place in the middle, or click " " to scale down and then place in center.
How to get free 3D modeling software?	<p>Website to download free 3D modeling software:</p> <p>http://www.hongkiat.com/blog/25-free-3d-modelling-applications-you-should-not-miss/</p>
How to get free 3D model to print?	<ol style="list-style-type: none"> 1. Use 3D modelling software such as UG, 3DMAX and above free software to design your 3D model file and save as STL format. 2. Use scanner to scan 3D model . We recommend scanner "Structure Sensor" which need work with APPLE IPAD. 3. Download 3D model from Website: http://www.thingiverse.com http://www.hongkiat.com/blog/download-free-stl-3d-models/ http://www.hongkiat.com/blog/60-excellent-free-3d-model-websites/

If you need more assistance, please feel free to contact with us:

Email: 3Dsupport@utec.com.mo